

POLYMER CONCRETE HANDHOLE

DATASHEETS **SPLIT LIDS**
24" X 36" X 24"

TIER 22: Driveway, parking lot, and off-roadway applications subject to occasional non deliberate heavy vehicular traffic.

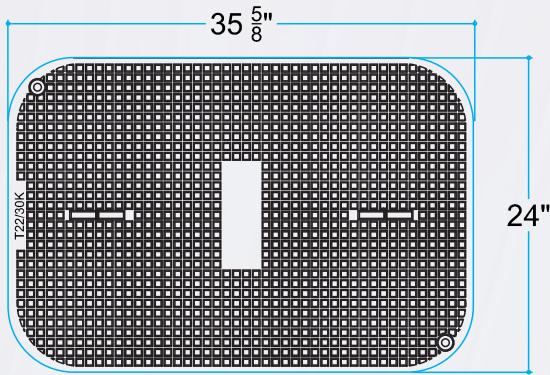

COVER TOP VIEW

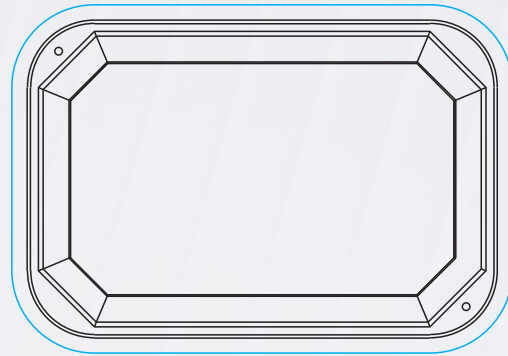

BOX TOP VIEW

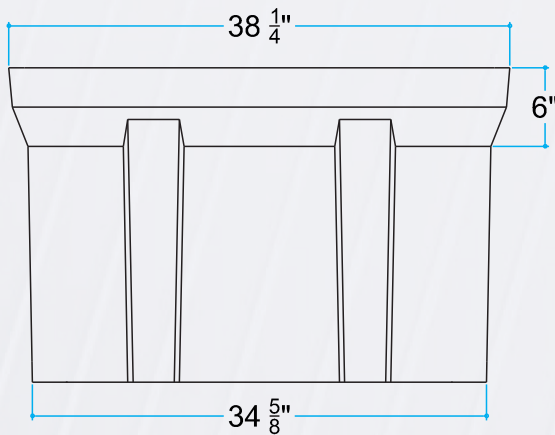

FRONT VIEW

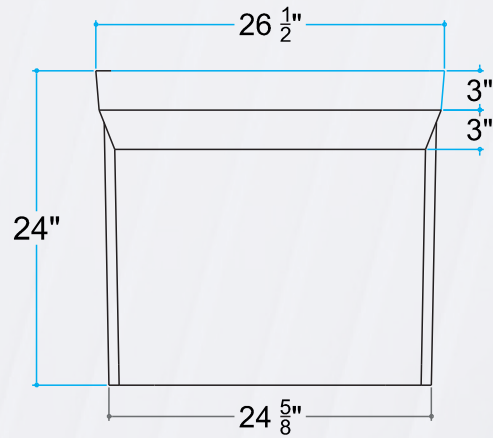

SIDE VIEW

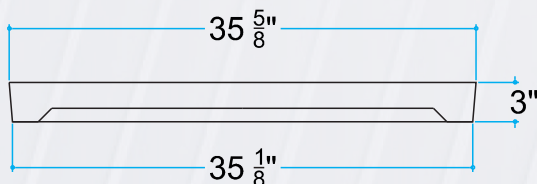

COVER FRONT VIEW

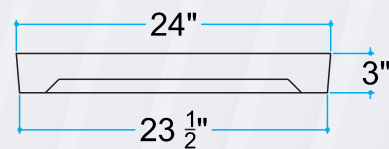

COVER SIDE VIEW





• FEATURES

- Polymer Concrete compressive strength= 11379 psi.
- Rupture modulus (average 3513 psi) according ASTM C-78
- Water absorption (average 0.136%)
- Non Conductive "dielectric"

• SPECIFICATIONS

- Polymer concrete cover and frame reinforced with fiberglass
- 3/16" Stainless steel lift pin
- 3/8" Stainless steel hex bolt fastening system
- Load Rating: Tier 22
- Dimensions: 24" x 36" x 24"
- 2 lids
- Tolerances: +- 1.5%
- Aproximate Weight:
 - Cover: 147 Lb
 - Box: 188 Lb
- Polymer concrete color: Beige



+1 (844) 238-4371



info@aetherfiber.com | aetherfibersolutions.com